

NR, NR4

In-line Pumps

$n \approx 2900$ rpm
 $n \approx 1450$ rpm



Construction

Close-coupled, single-impeller, centrifugal pumps; electric motor with extended shaft directly connected to the pump. Pump casing with suction and delivery connections with the same diameter and on the same axis (in-line).

Connections: Flanges PN 10, EN 1092-2.

Counterflanges (on request)

Sizes	Flanges
NR, NR4 32, 40, 50, 65	Screwed flanges PN 16, EN 1092-1
NR4 100, NR4 125	Flanges for welding PN 10, EN 1092-1

Version with frequency converter (on request)

Applications

For clean liquids, without abrasives, which are non-aggressive for the pump materials (contents of solids up to 0.2%).
 For heating, conditioning, cooling and circulation plants.
 For civil and industrial applications.
 When low noise operation is required ($n \approx 1450$ rpm).

Operating conditions

Liquid temperature from -10 °C to $+90$ °C.
 Ambient temperature up to 40 °C.
 Total suction lift up to 7 m.
 Maximum permissible working pressure up to 10 bar.
 Continuous duty.

The electropumps NR, NR4 series comply with the European Regulation no. 547/2012.

Materials

Component	Material
Pump casing Lantern bracket	Cast iron GJL 200 EN 1561
Impeller	Cast iron GJL 200 EN 1561 (Brass P-Cu Zn Pb 2 EN 1982 for NR-NR4 32, 40, 50)
Shaft	Chrome-nickel steel AISI 303 for pumps up to 1.1 kW Chrome steel AISI 430 for pumps from 1.5 to 18,5 kW
Mecanical seal	Carbon - Ceramic - NBR
Counterflanges	Steel Fe 42 UNI 7070

Special features on request

- Other voltages. - Protection IP 55. - Frequency 60 Hz
- Special mechanical seal. - Higher or lower liquid or ambient temperatures.
- Motor suitable for operation with frequency converter up to 0,55 kW for NR4 and up to 0,75 kW for NR.

Motor

2-pole induction motor, 50 Hz ($n \approx 2900$ rpm).
NR : three-phase $230/400$ V $\pm 10\%$ up to 3 kW;
 $400/690$ V $\pm 10\%$ from 4 to 18,5 kW.

NRM : single-phase 230 V $\pm 10\%$.
 4-pole induction motor, 50 Hz ($n \approx 1450$ rpm).
NR4: three-phase $230/400$ V $\pm 10\%$ up to 3 kW;
 $400/690$ V $\pm 10\%$ for 4 kW.

NRM4: single-phase 230 V $\pm 10\%$.
 Insulation class F.
 Protection IP 54.
 Motor suitable for operation with frequency converter from 0,75 kW for NR4 and from 1,1 kW for NR.
Classification scheme IE3 for three-phase motors from 0,75 kW.
 Constructed in accordance with EN 60034-1, EN 60034-30-1.
 EN 60335-1, EN 60335-2-41.

Coverage chart

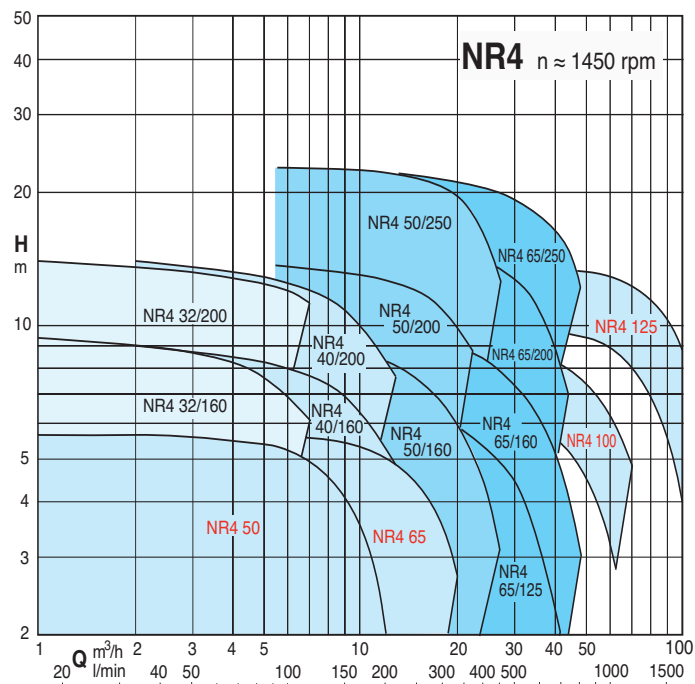
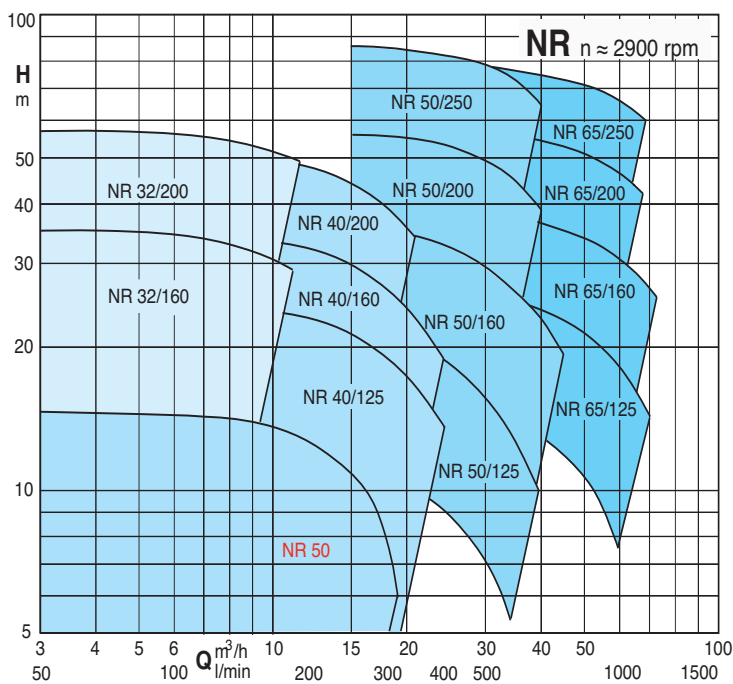

Pumps with frequency converter

The **NR EI, NR4 EI**, pumps are available with power from 0,25 kW up to 18,5 kW, the pumps are equipped with **I-MAT** installed on board which allows to realize a variable-speed system extremely compact and efficient, ideal in applications of water supply and in the distribution of hot and cold water.

The pump is equipped with transducers suitable for operation and is already programmed at the factory.

Advantages

- Energy saving
- Compact design
- Easy to use
- Programmable to suit the system requirements
- Reliability

Costruction

The system comprises of:

- Pump
- Induction motor
- I-MAT Frequency converter
- Motor adapter for the motor mounting of the frequency converter
- Connection cable between frequency converter and induction motor
- Transducers

Main features

Rated motor power output from 0,25 kW to 18,5 kW

Control range from 1750 to 2900 rpm (2-pole)

Control range from 870 to 1450 rpm (4-pole)

Protection against dry running

Protection against operations with closed valve ports

Protection against system leakages

Protection against overcurrent in the motor

Protection agains overvoltage and undervoltage of the power supply

Protection against current unbalances between phases



Operating modes



Constant pressure mode with pressure transducer

In this mode, the system maintains the preset pressure when the flow required by the installation changes.

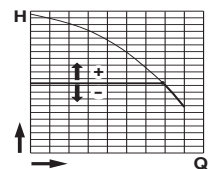

Proportional pressure mode with pressure transducer

In this mode the system changes the working pressure according to the required flow rate.

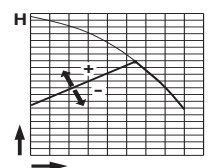

Constant flow mode with flow meter

In this mode the system maintains a constant flow rate value in a point of the installation according to the required pressure.

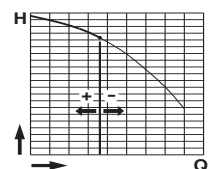

Fixed speed mode with setting of the speed preferential rotation.

In this mode, by changing the working frequency, you may choose any operational curve included within the working range.

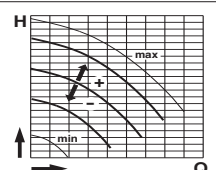

Constant temperature mode with temperature transducer

In this mode the system keeps the temperature constant inside a system by changing the speed of the pump.

Performance n ≈ 2900 rpm

3 ~	230V 400V		1 ~	230V P ₁		P ₂		Q m³/h l/min																					
	A	A		A	kW	kW	HP		0	6	6,6	7,5	8,4	9,6	10,8	12	13,2	15	16,8	18,9									
NR 50D/A	2,3	1,3	NRM 50D/A	3,6	0,72	0,45	0,6	H	11,6	11	10,8	10,5	10,2	9,5	8,5	7	6												
NR 50C/B	3,7	2,2	NRM 50C/A	5,7	1,13	0,75	1	m	16,2	16	15,9	15,8	15,7	15,3	14,6	14	13	11	9	5,5									

3 ~	230V 400V		P ₂	Q m³/h l/min																									
	A	A			kW	HP	0	2,4	3	3,6	4,8	6	6,6	7,5	8,4	9,6	10,8	12	13,2	15	16,8								
NR 32/160B/A	4,6	2,7	1,1	1,5	H	28,1	27,9	27,6	27,3	26,5	25,6	25,1	24,3	23,4	21,9	20													
NR 32/160A/A	7,5	4,3	1,5	2		36,8	36,3	36,1	35,7	35	34,3	33,8	33,2	32,4	31,2	29,7													
NR 32/200B/A	9,2	5,3	2,2	3	m	42,5	41,6	41,3	40,6	39,8	39,3	38,5	37,7	36,5	35,1	33,4													
NR 32/200A	11,5	6,6	3	4		51,2	49,7	49,5	48,9	48,2	47,9	47,2	46,5	45,4	44,2	42,8	41,2	37,9											
NR 32/200S/A	9,4	9,4	4	5,5		58	57,4	57,2	56,7	56,1	55,8	55,1	54,4	53,3	52	50,5	48,8	45,9	42,6										

3 ~	230V 400V		P ₂	Q m³/h l/min																									
	A	A			kW	HP	0	6,6	7,5	8,4	9,6	10,8	12	13,2	15	16,8	18,9	21	24										
NR 40/125C	4	2,3	0,75	1	H	15,5	15,7	15,5	15,3	14,8	14,3	13,6	12,9	11,6	10,2	8,1	5,8												
NR 40/125B/A	4,6	2,7	1,1	1,5		19,5	19,8	19,6	19,4	19,0	18,5	18,0	17,5	16,5	15,2	13,6	11,6	8,5											
NR 40/125A/A	7,5	4,3	1,5	2	m	23,3	23,7	23,7	23,6	23,4	23,1	22,8	22,4	21,7	20,6	19,1	17,3	14,2											
NR 40/160B/A	7,5	4,3	1,5	2		26,1	25,7	25,4	25,1	24,6	24,0	23,3	22,6	21,4	19,7	17,3	14,4	9,9											
NR 40/160A/A	9,2	5,3	2,2	3	m	33,6	32,9	32,6	32,3	31,8	31,3	30,6	29,9	28,7	27,2	25,2	23,1	19,4											
NR 40/200B	11,5	6,6	3	4		41,9	40,2	39,7	39,2	38,5	37,6	36,7	35,7	33,8	31,0	26,9	22,0												
NR 40/200A/A	9,4	9,4	4	5,5		52,4	49,6	49,1	48,5	47,6	46,7	45,7	44,7	43,0	41,2	38,6	34,8												

3 ~	230V 400V		P ₂	Q m³/h l/min																									
	A	A			kW	HP	0	15	16,8	18,9	21	24	27	30	33	37,8	39	42	45										
NR 50/125F/A	4,7	2,7	1,1	1,5	H	14,9	13,8	13,4	12,8	12,1	11	9,9	8,4	6,9															
NR 50/125C/A	7,5	4,3	1,5	2		17,7	17,4	17	16,5	16	15	13,9	12,6	11,3	9	8,3													
NR 50/125A/B	9,2	5,3	2,2	3	m	22,2	21,7	21,4	21	20,6	19,8	18,8	17,5	16,3	14,1	13,5	12												
NR 50/160C/B	9,2	5,3	2,2	3		23,1	21,9	21,4	20,6	19,9	18,6	17,3	15,6	13,8	10,8	10													
NR 50/160B/A	11,5	6,6	3	4	m	28,6	27,9	27,4	26,7	26	24,6	23,1	21,3	19,7	16,6	15,7	13,6												
NR 50/160A/B	9,4	9,4	4	5,5		36,6	35,5	35,1	34,5	33,7	32,7	31,2	29,4	27,5	24,3	23,4	21,3	19,1											
NR 50/200D/B	9,4	9,4	4	5,5		41,8	37,8	36,8	35,7	34,5	32,4	30,1	27,6	24,9															
NR 50/200B/A	10,8	10,8	5,5	7,5		50,9	48,5	47,7	46,8	45,7	43,9	41,7	39,2	36,5															
NR 50/200A/A	14,3	14,3	7,5	10		56,7	54,9	54,3	53,4	52,4	50,7	48,9	46,5	44,1	39,7	38,8													
NR 50/250C/B	18,5	18,5	9,2	12,5		61,2	58,8	58	57,3	56,5	55	53,2	51,1	48,9	44,8	43,1	39,4												
NR 50/250B/B	21,5	21,5	11	15		69,4	67	66,4	65,5	64,8	63,2	61,5	59,6	57,7	53,8	52,6	50												
NR 50/250A/B	27,3	27,3	15	20		87	84,6	84,1	83,2	82,3	80,7	78,8	76,9	74,3	69,8	68,4	65,2												

3 ~	230V 400V		P ₂	Q m³/h l/min																									
	A	A			kW	HP	0	21	24	27	30	33	37,8	42	48	54	60	66	69	72									
NR 65/125F/B	9,2	5,3	2,2	3	H	16,5	16	15,7	15,3	14,8	14,3	13,5	12,5	11,1	9,5	7,3	5,3												
NR 65/125D/A	11,5	6,6	3	4		21,1	20,2	19,9	19,6	19,2	18,7	17,9	16,9	15,2	13,3	11,3	9,1												
NR 65/125A/B	9,4	9,4	4	5,5	m	25	24,4	24,1	23,8	23,4	23	22,2	21,4	19,8	18	15,9	13,7	12,4											
NR 65/125S/B	9,4	9,4	4	5,5		27,2	26,3	26	25,7	25,4	25	24,3	23,6	22,1	20,3	18,3	16,1	14,7											
NR 65/160B/A	10,8	10,8	5,5	7,5		31,9	32	31,7	31,4	30,9	30,4	29,5	28,6	26,8	24,8	22,2	19,7	18,3	16,7										
NR 65/160A/A	14,3	14,3	7,5	10		39	39,3	39	38,7	38,3	37,9	36,9	36,1	34,7	32,9	30,6	28,1	26,7	25,3										
NR 65/200B/B	18,5	18,5	9,2	12,5	m	47,1	46,7	45,9	45,1	44,4	43,6	42	40,5	37,9	35,3	32,4	28,3												
NR 65/200A/B	21,5	21,5	11	15		54,2	53,3	52,8	52,3	51,5	50,7	49,2	47,5	45,1	41,9	38,1	34,5												
NR 65/200S/B	27,5	27,5	15	20		60,4	60,5	60,2	59,6	59	58	56,3	54,5	52,2	49,5	46,5	42,7												
NR 65/250C/B	21,5	21,5	11	15		54,6	54,8	54,2	53,5	52,8	52	50,5	48,9	46,3	43,5	40,6	37,3												
NR 65/250B/B	27,3	27,3	15	20		67,1	67,2	66,7	66	65,1	64,3	62,8	61,3	58,6	55,8	52,9	49,7												
NR 65/250A/C	34	34	18,5	25		78,5	78,5	77,8	77,3	76,7	76	74,8	73,6	71,1	68,4	65,5	62,2												

P1 Max. power input. P2 Rated motor power output. Tolerances according to UNI EN ISO 9906:2012

Characteristic curves $n \approx 2900$ rpm

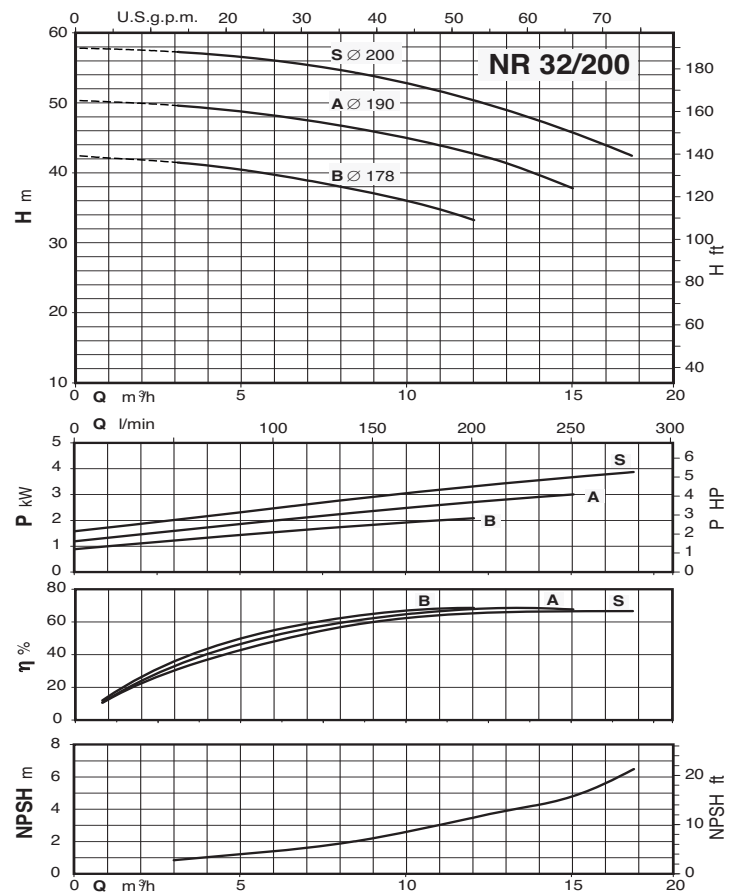
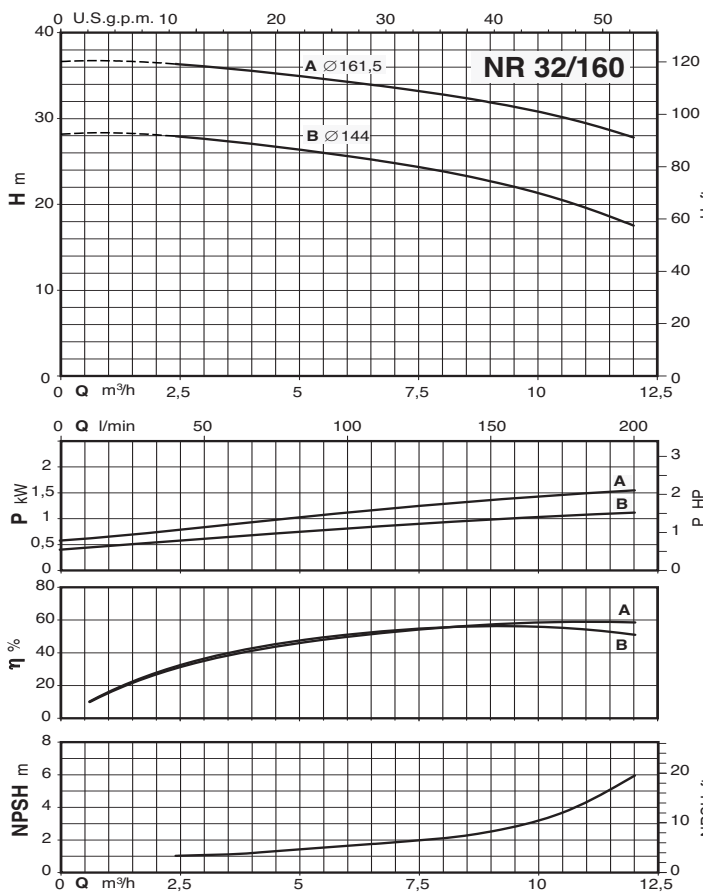
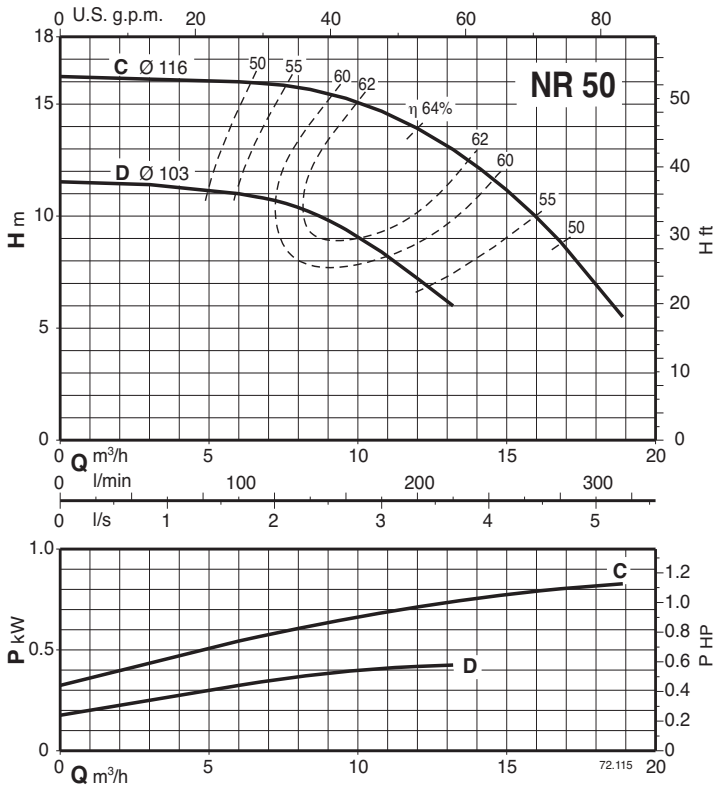

Characteristic curves $n \approx 2900$ rpm

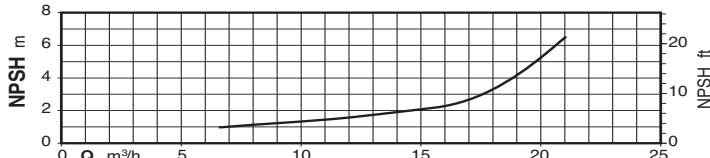
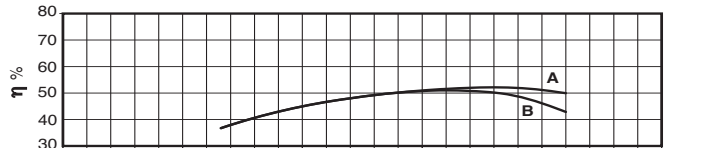
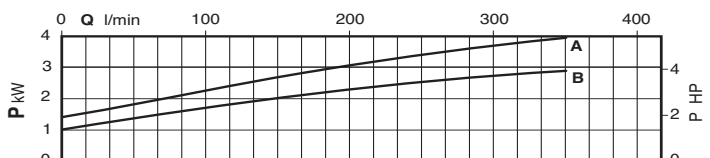
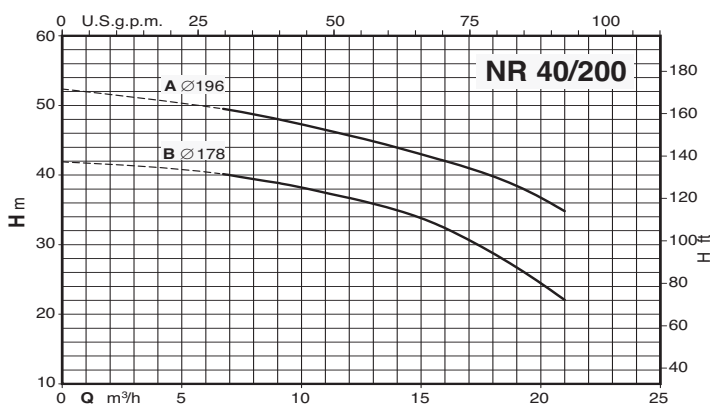
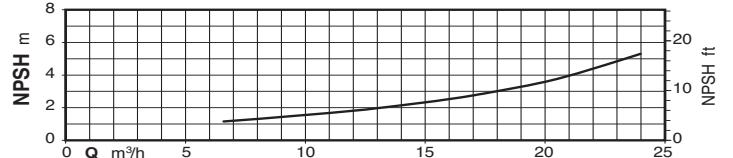
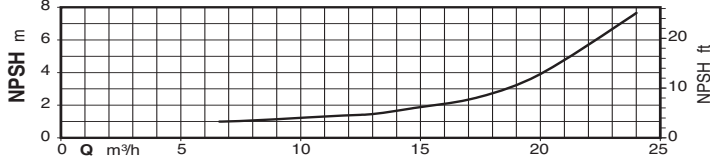
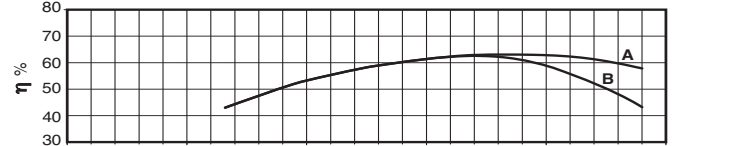
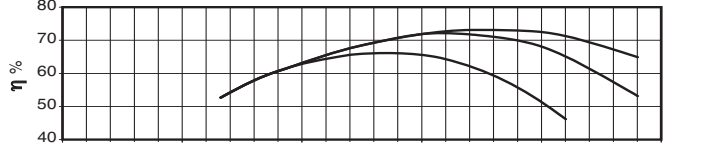
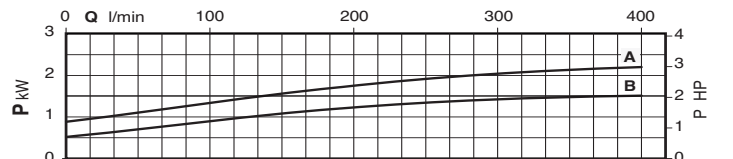
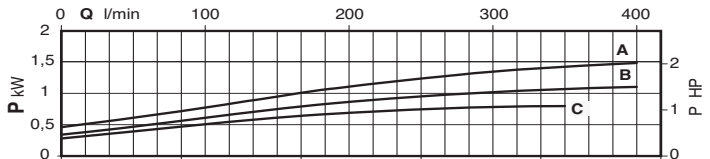
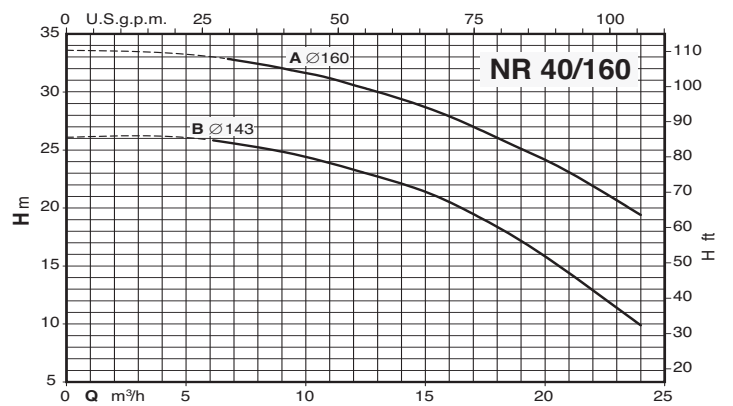
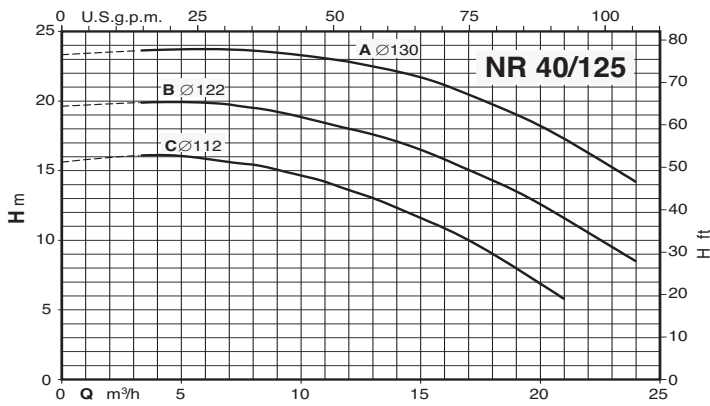

Characteristic curves $n \approx 2900$ rpm

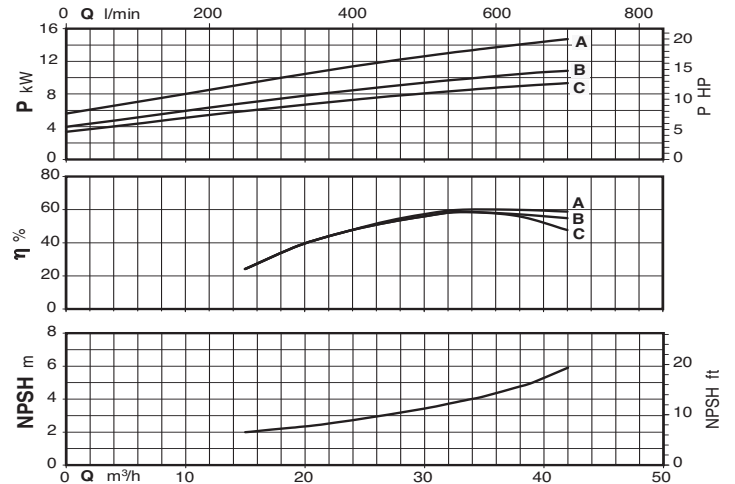
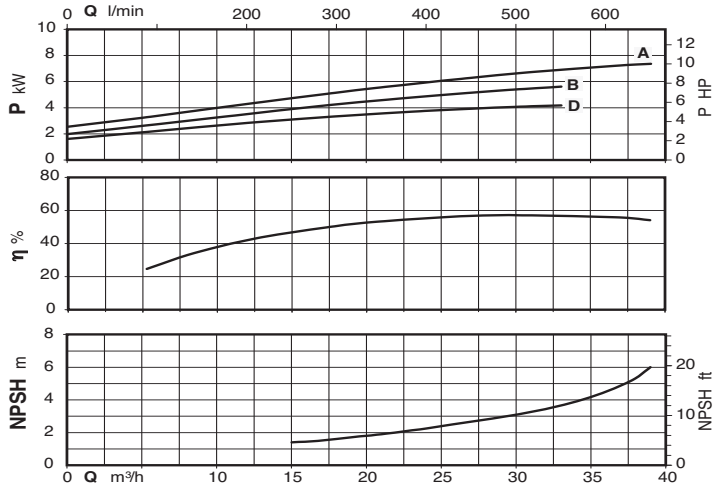
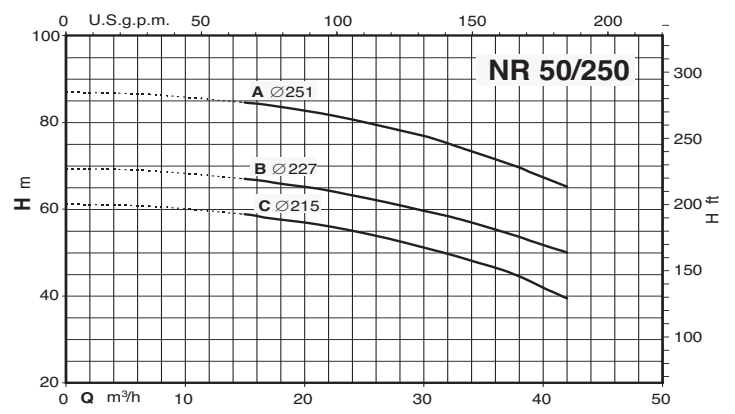
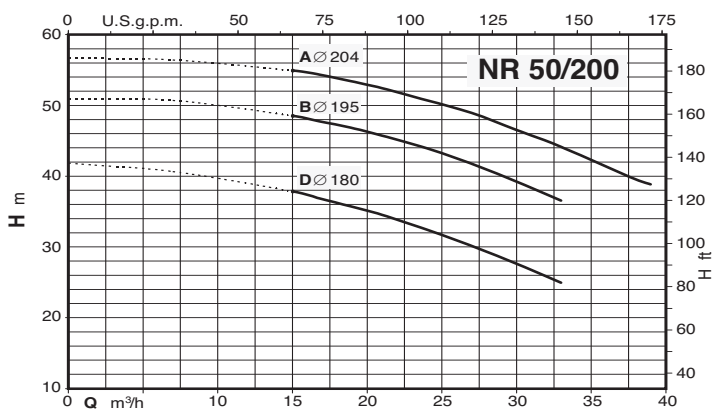
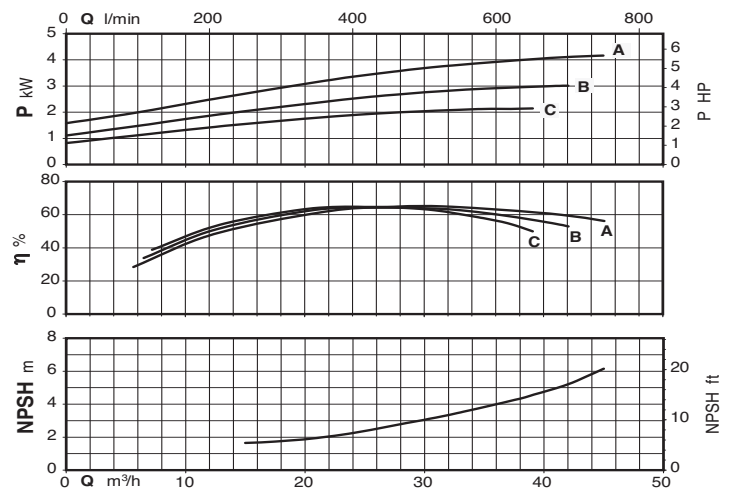
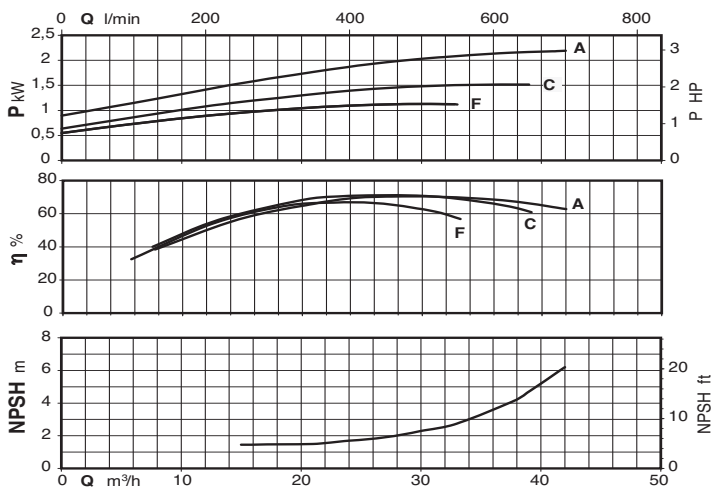
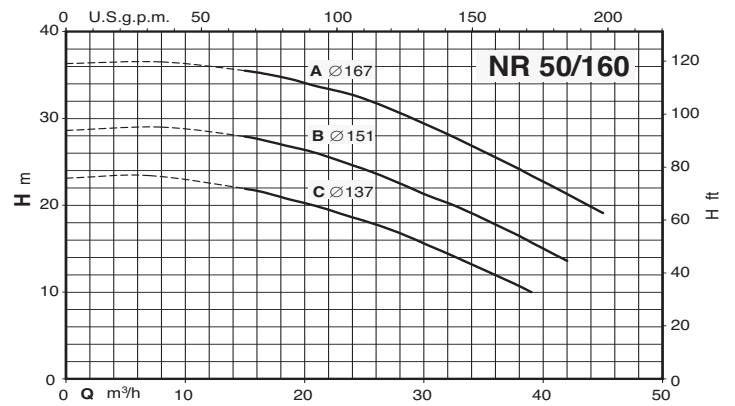
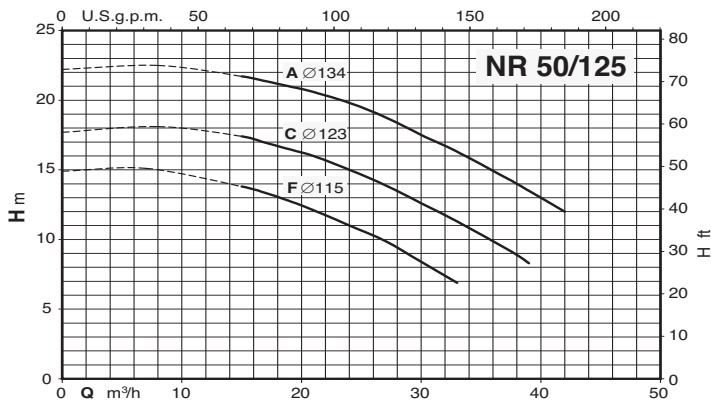

Characteristic curves $n \approx 2900$ rpm

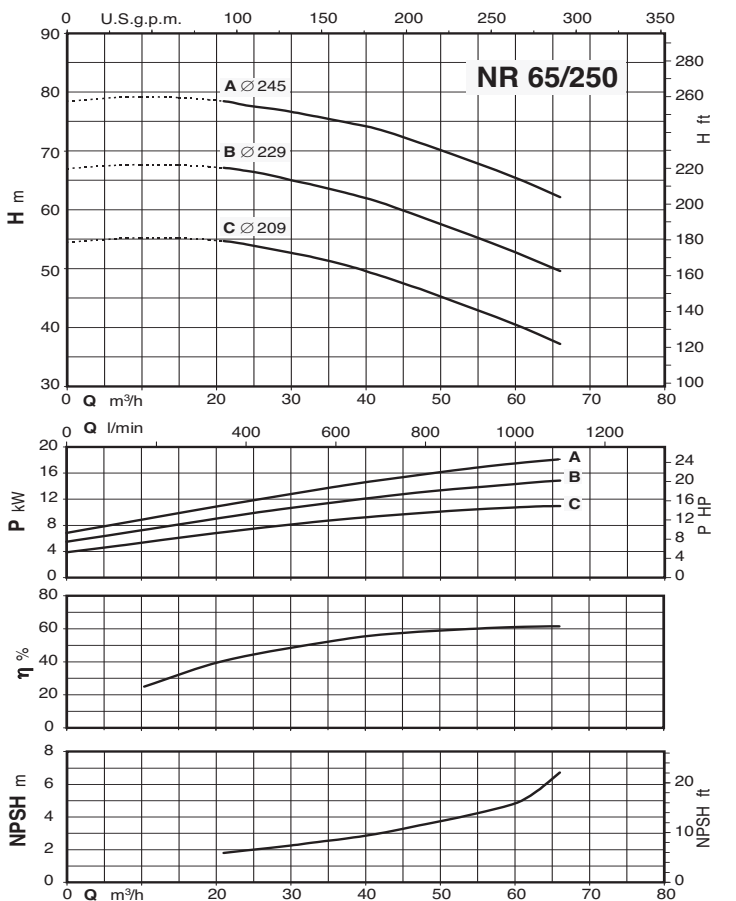
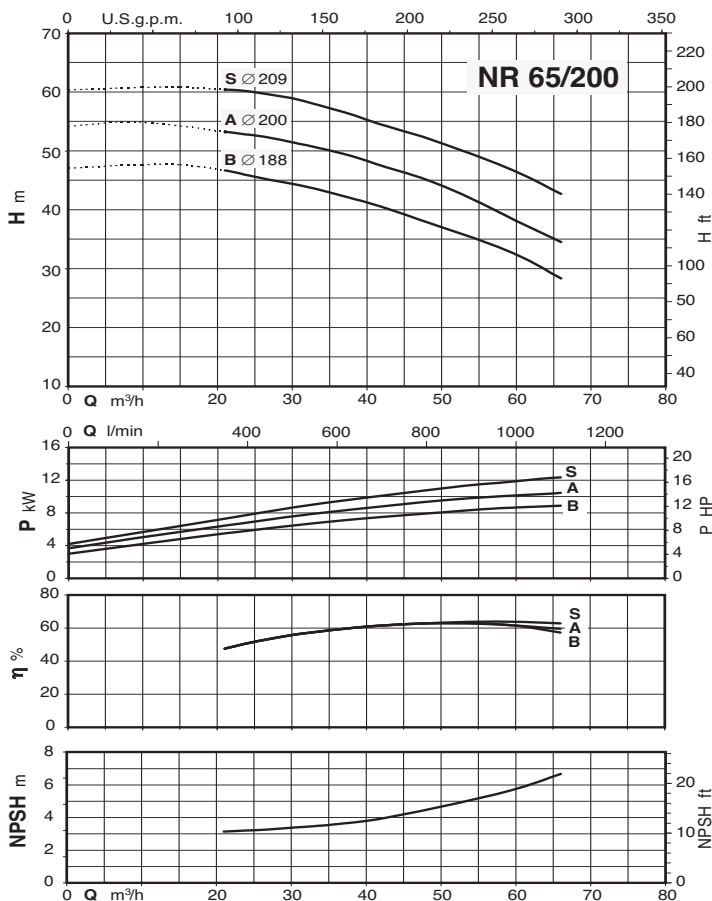
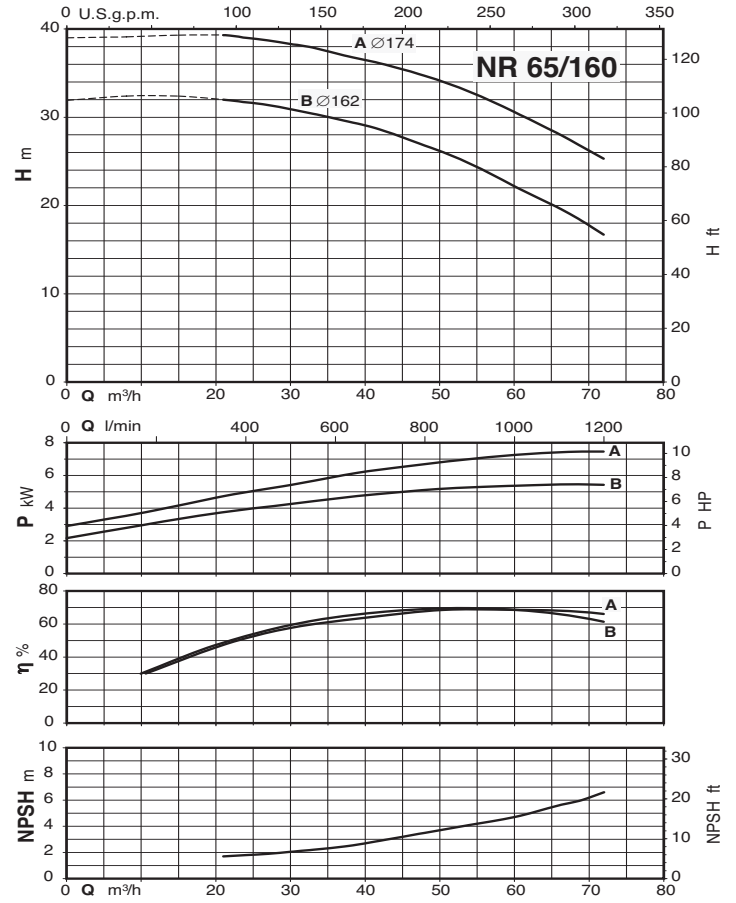
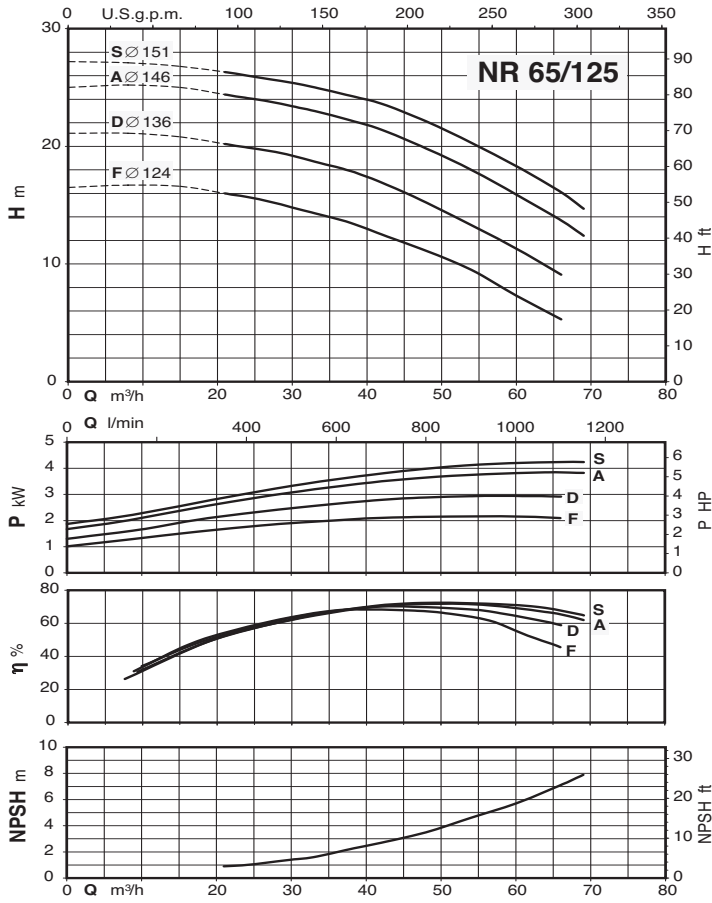

Characteristic curves $n \approx 1450$ rpm

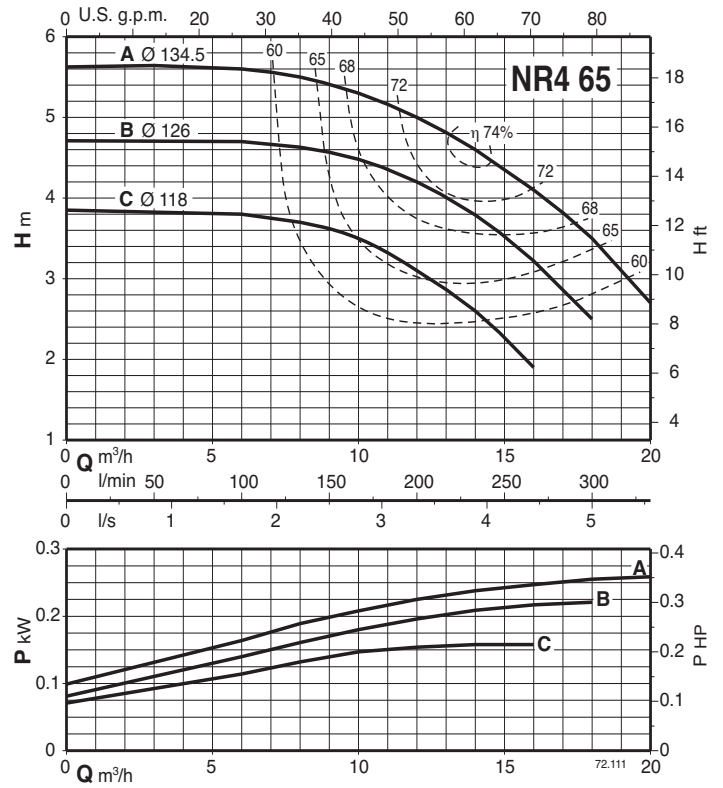
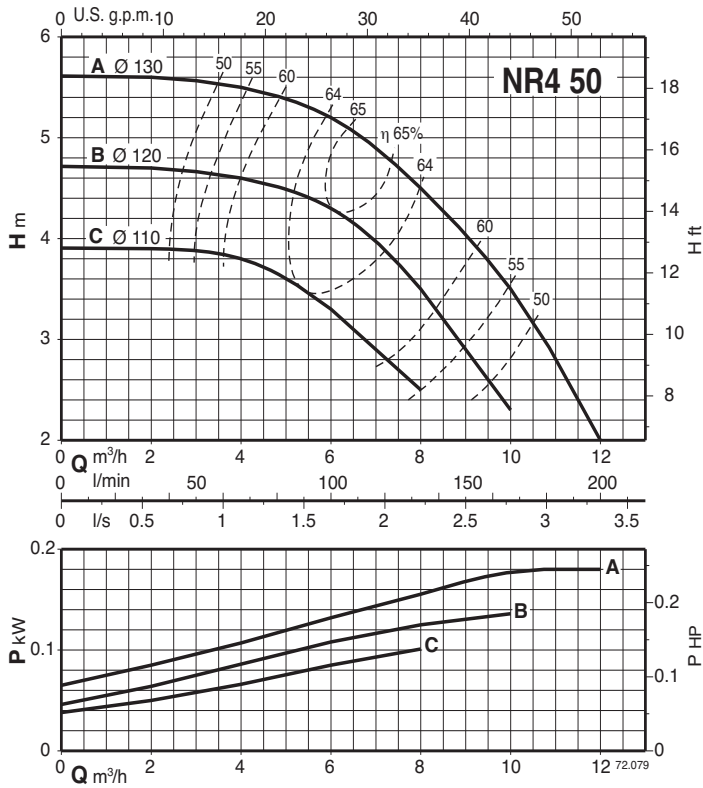

Characteristic curves $n \approx 1450$ rpm

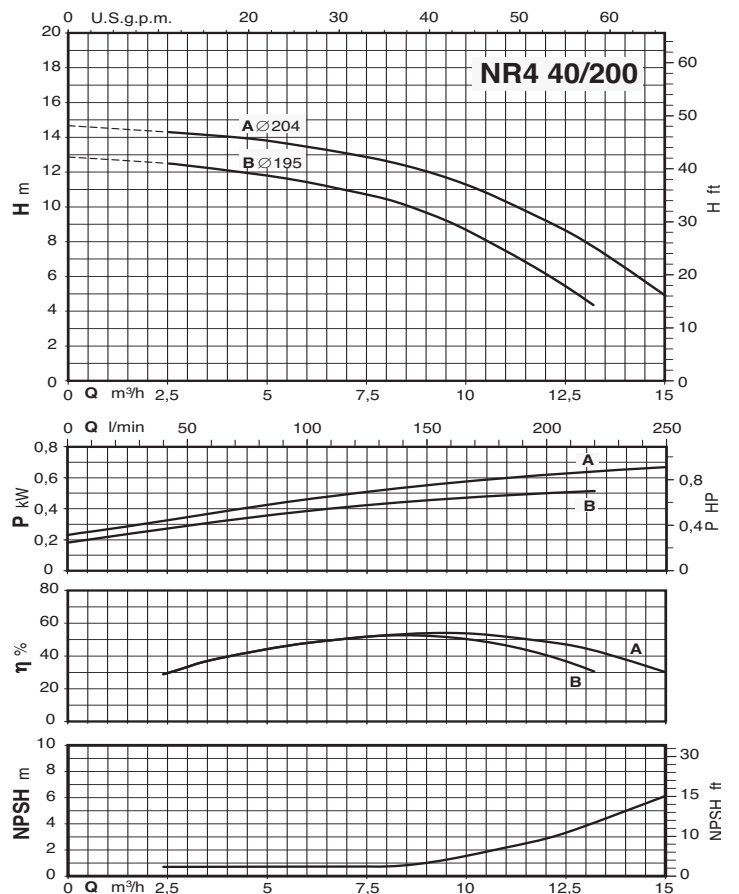
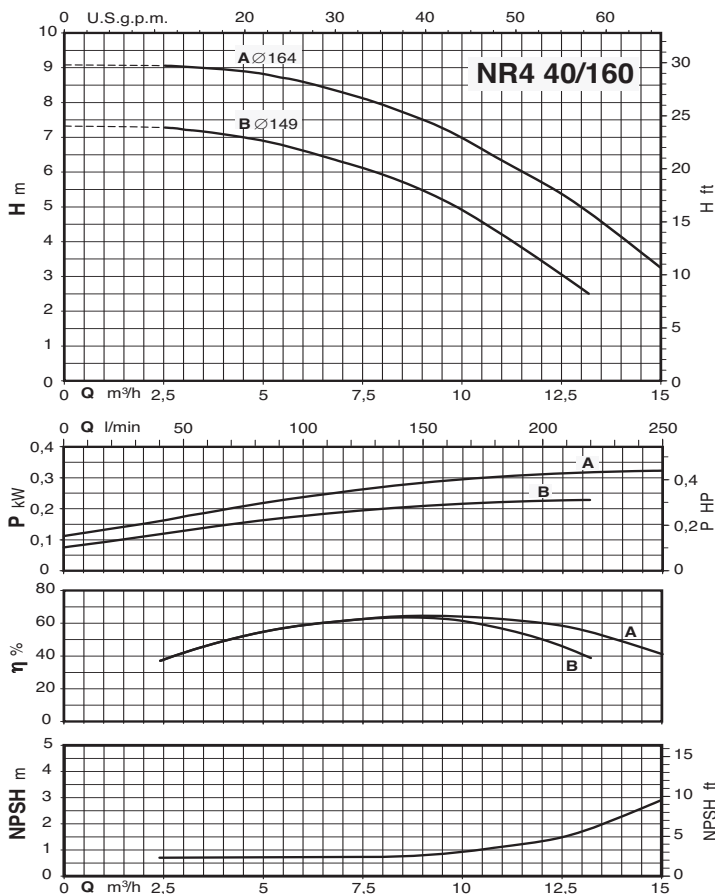
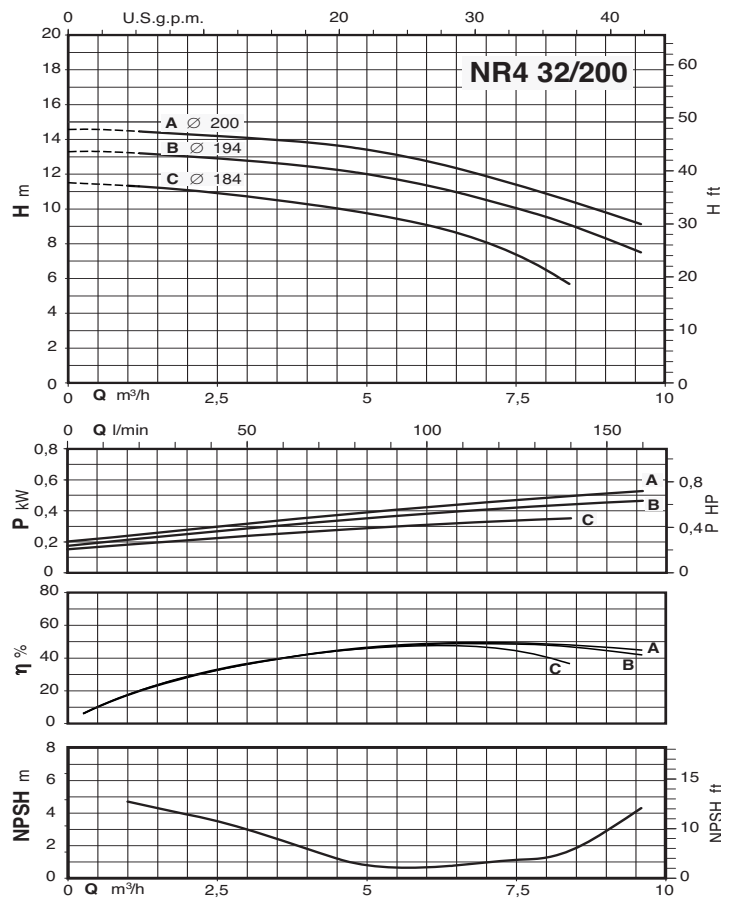
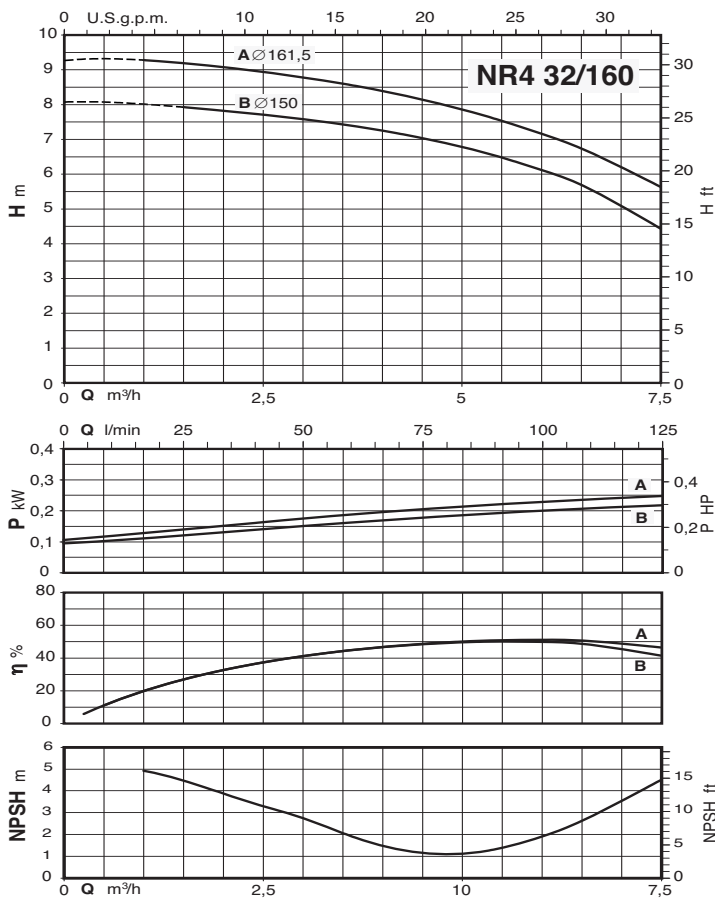

Characteristic curves $n \approx 1450$ rpm

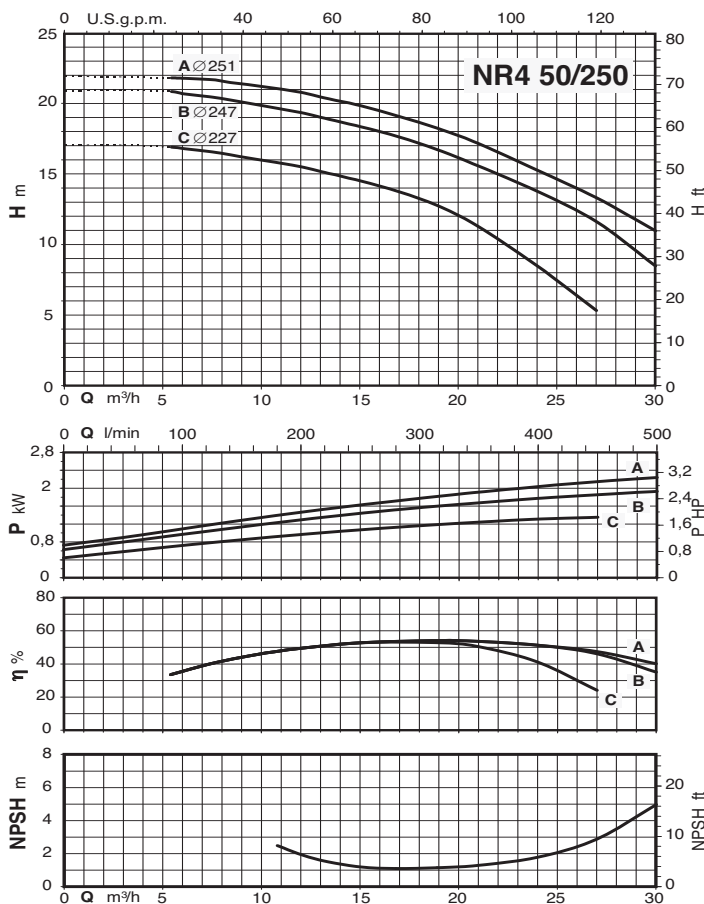
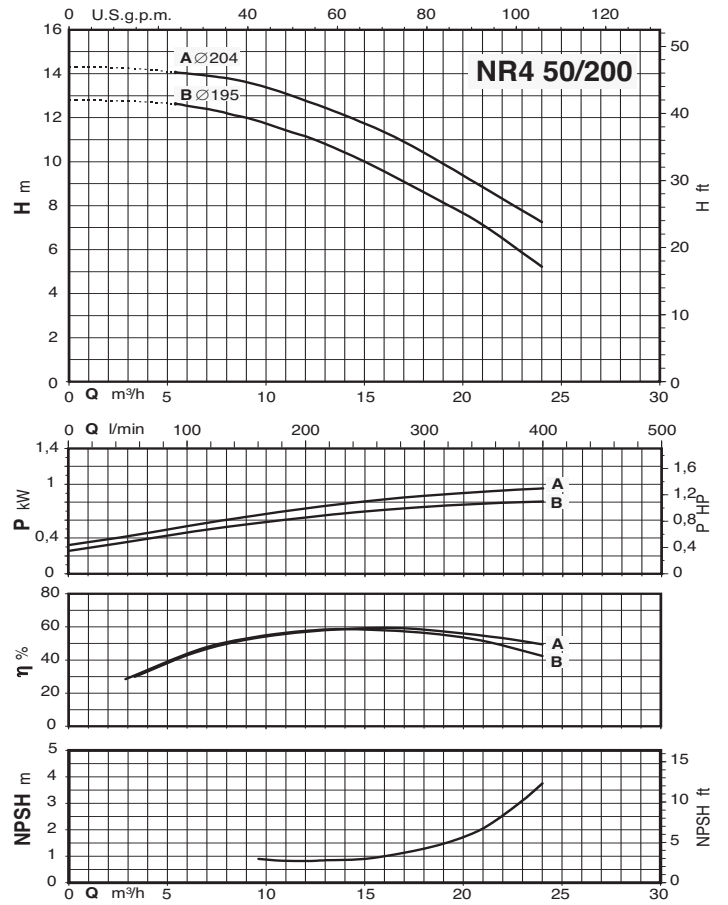
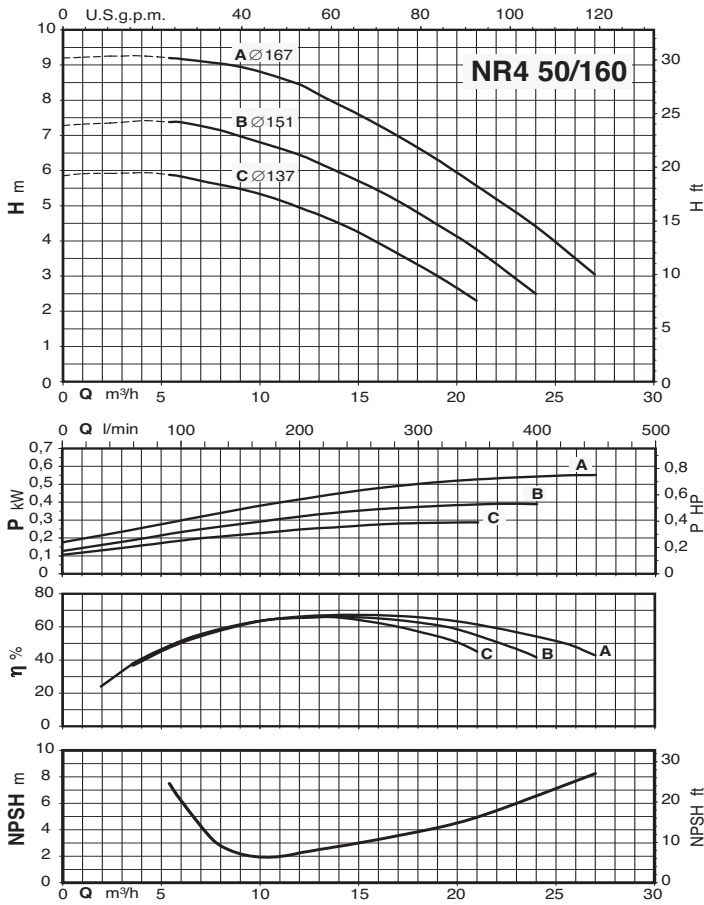

Characteristic curves $n \approx 1450$ rpm

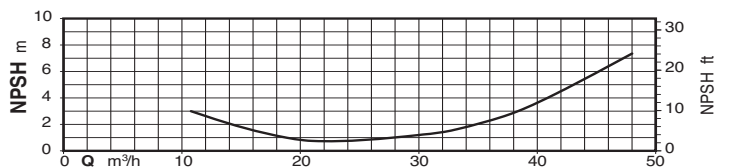
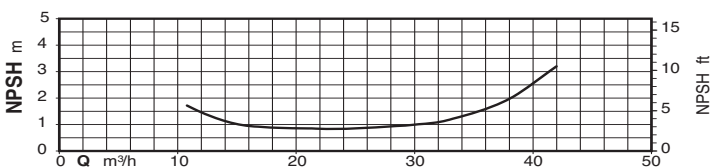
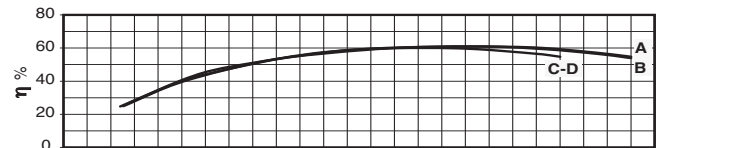
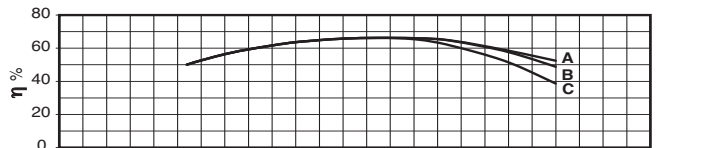
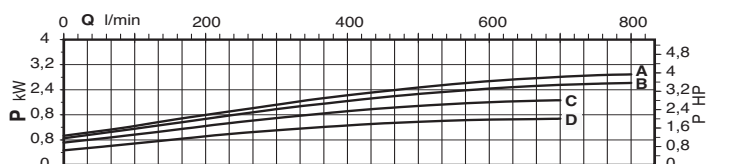
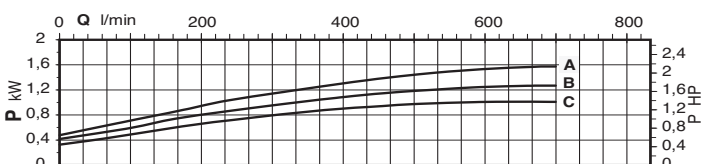
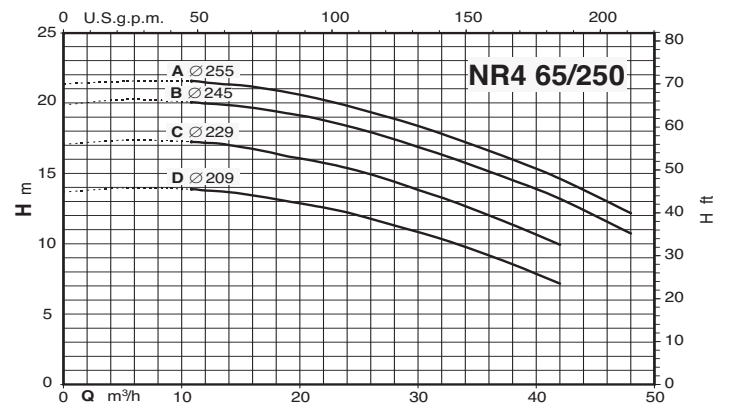
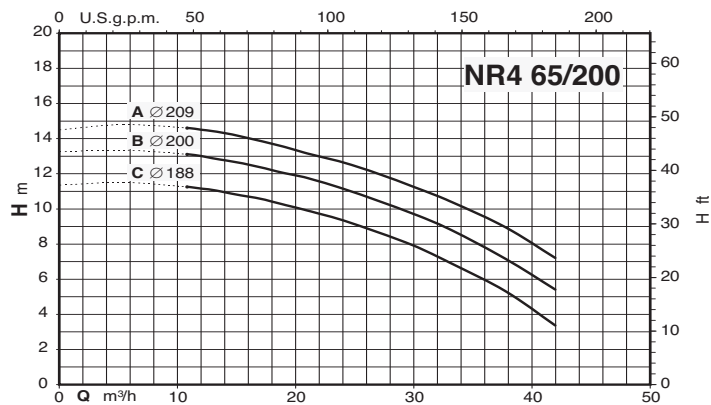
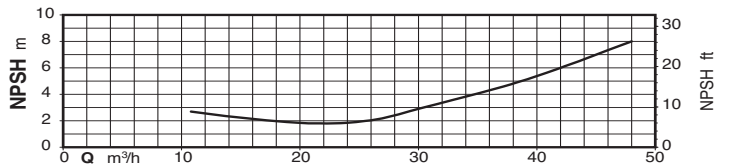
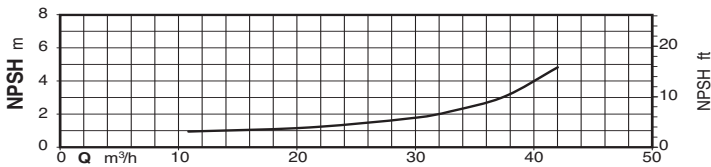
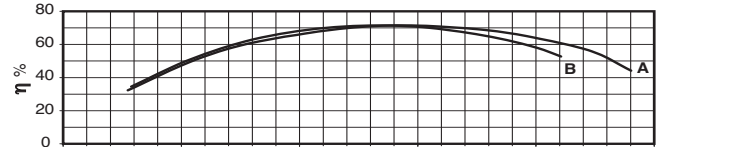
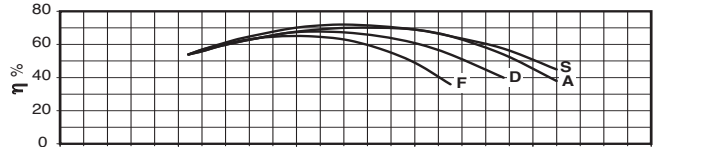
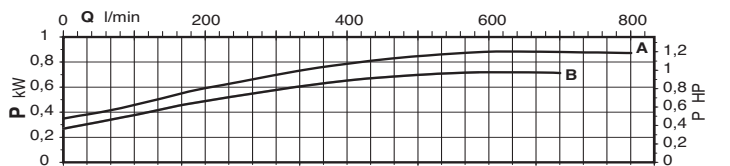
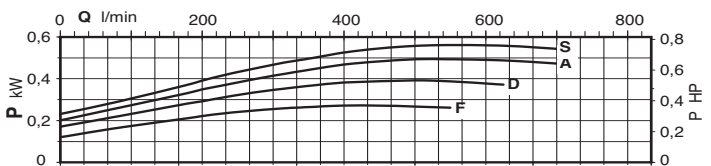
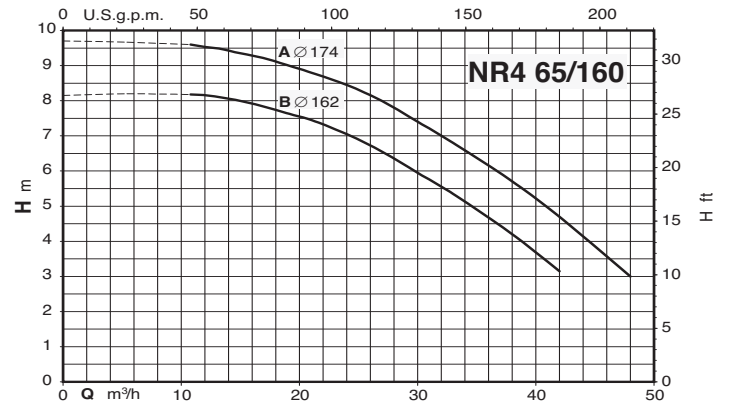
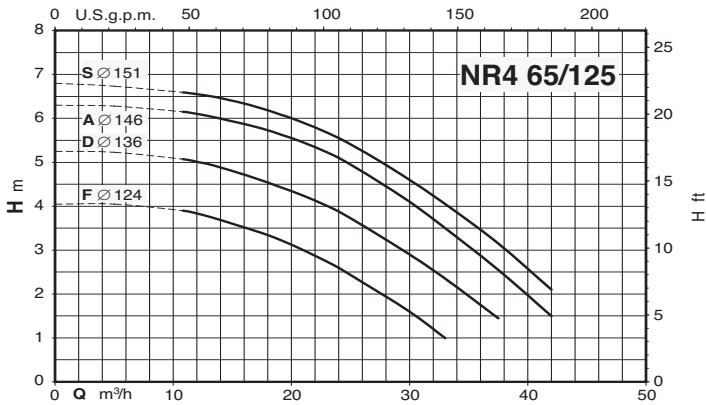

Characteristic curves $n \approx 1450$ rpm

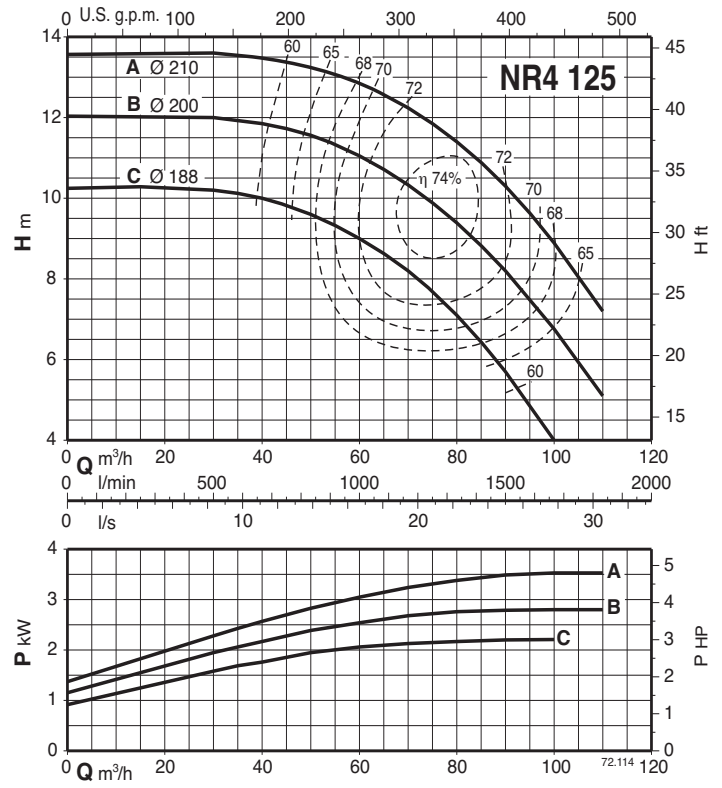
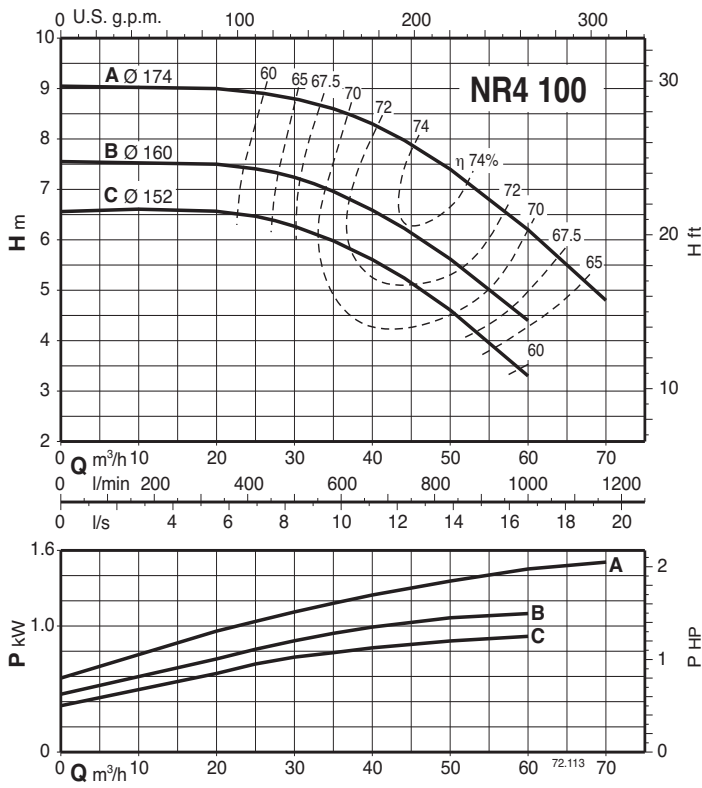

Dimensions and weights

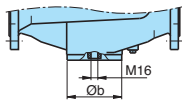
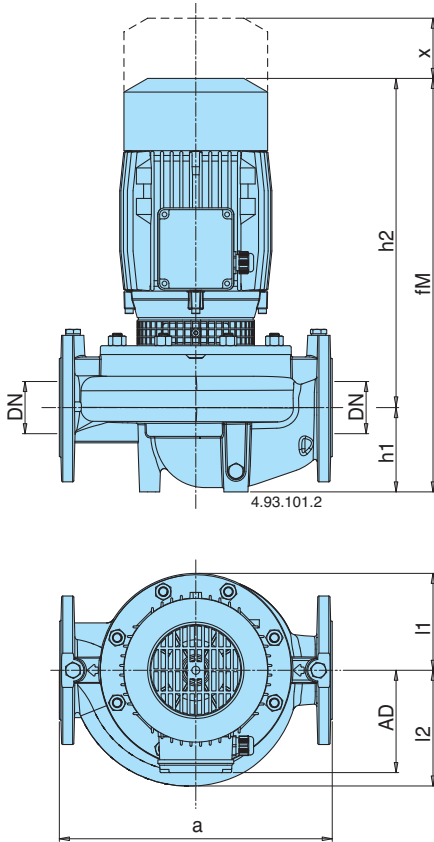

Flanges PN 10, EN 1092-2

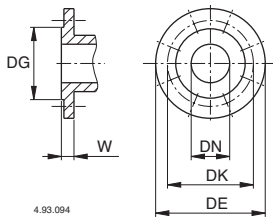

DN	mm					W
	DG	DK	DE	Holes N°	Ø	
32	76	100	140	4	19	18
40	84	110	150	4	19	18
50	99	125	165	4	19	20
65	118	145	185	4	19	20
80	132	160	200	8	19	22
100	156	180	220	8	19	24
125	184	210	250	8	19	24

TYPE	mm										kg
	DN	a	fM	h1	h2	Øb	AD	l1	l2	x	
NR 50D/A-C/B	50	320	360	90	270	98	111	93	100	70	21,7-23,8
NR 32/160A/A-B/A	32	340	421	80	341	-	128	102	102	60	28,6-27
NR 32/200B	32	440	469	85	384	-	128	126	126	60	36,3
NR 32/200A/A-S/A	32	440	495	85	410	-	138	126	126	60	44-47
NR 40/125A/A-B/A-C	40	320	420	81	339	-	128	93	98	70	29,5-27,5-26,5
NR 40/160B/A	40	320	430	81	349	-	128	119	119	75	35,0
NR 40/160A/A	40	320	470	81	389	-	128	119	119	75	40,0
NR 40/200A/A-B	40	440	496	81	430	-	138	140	140	75	56,6-53,4
NR 50/125C/A-F/A	50	340	437	90	347	-	128	96	115	75	31,5-29,5
NR 50/125A/B	50	340	477	90	387	-	128	96	115	75	36,1
NR 50/160C/B	50	340	480	90	390	-	128	120	128	75	41,6
NR 50/160A/B-B/A	50	340	506	90	416	-	138	120	128	75	51,8-48,5
NR 50/200D/B	50	440	516	100	416	-	138	140	140	80	59,7
NR 50/200A/A-B/A	50	440	544	100	444	-	160	140	140	80	77,2-69,7
NR 50/250C/B	50	440	657	100	557	-	185	175	175	85	114
NR 50/250B/B	50	440	707	100	557	-	185	175	175	85	121
NR 50/250A/B	50	440	732	100	632	-	185	175	175	85	149,5
NR 65/125F/B	65	340	494	105	389	-	128	121	145	95	46
NR 65/125S/B-A/B-D/A	65	340	520	105	415	-	138	121	145	95	56,1-56,1-54,6
NR 65/160A/A-B/A	65	340	552	105	447	-	160	121	142	95	74-67,5
NR 65/200B/B	65	475	666	105	561	-	185	140	153	90	108
NR 65/200A/B	65	475	716	105	611	-	185	140	153	90	114
NR 65/200S/B	65	475	741	105	636	-	185	140	153	90	142,5
NR 65/250C/B	65	475	722	105	567	-	185	175	175	90	134
NR 65/250B/B	65	475	747	105	642	-	185	175	175	90	155
NR 65/250A/C	65	475	793	105	688	-	206	175	175	90	-

TYPE	mm										kg
	DN	a	fM	h1	h2	Øb	AD	l1	l2	x	
NR4 50A/A-B/A-C/A	50	320	360	90	270	98	111	93	100	70	22-22-22
NR4 65A/A-B/A-C/A	65	360	370	100	270	118	111	102	114	70	28-28-28
NR4 100A/B-B-C/B	100	500	549	150	399	162	138	153	173	105	67-59-59
NR4 125C/B	125	600	589	170	419	194	138	172	195	120	91,5
NR4 125A/A-B/A	125	600	608	160	438	194	160	172	195	120	110-108
NR4 32/160A-B	32	340	421	80	341	-	128	102	102	60	23-22,9
NR4 32/200B-C	32	440	429	85	344	-	128	126	126	60	30,8-29,2
NR4 32/200A/A	32	440	469	85	344	-	128	126	126	60	
NR4 40/160A-B	40	320	430	81	349	-	128	119	119	75	31,5 - 31
NR4 40/200B	40	440	430	81	349	-	128	140	140	75	39,5
NR4 40/200A/A	50	440	470	81	349	-	128	140	140	75	43
NR4 50/160B-C	50	340	440	90	350	-	128	120	128	75	35,5-33,5
NR4 50/160A/B	50	340	480	90	350	-	128	120	128	75	37,5
NR4 50/200A/B-B/B	50	440	516	100	416	-	138	140	140	80	56
NR4 50/250C/B	50	440	516	100	416	-	138	175	175	85	77,5
NR4 50/250A/A-B/B	50	440	545	100	445	-	160	175	175	85	93,5-80
NR4 65/125D-F	65	340	454	105	349	-	128	121	145	95	39-37
NR4 65/125S/B-A/B	65	340	494	105	349	-	128	121	145	95	42-41,5
NR4 65/160A/B-B/B	65	340	504	105	399	-	138	121	142	95	42,7-42,5
NR4 65/200C/B	65	475	536	105	431	-	138	140	153	90	52
NR4 65/200B/B	65	475	536	105	431	-	138	140	153	90	60
NR4 65/200A/B	65	475	552	105	447	-	160	140	153	90	64,5
NR4 65/250C/B-D/B	65	475	555	105	450	-	160	175	175	90	75,5-75,5
NR4 65/250A/A-B/A	65	475	555	105	450	-	160	175	175	90	98-85

Installation

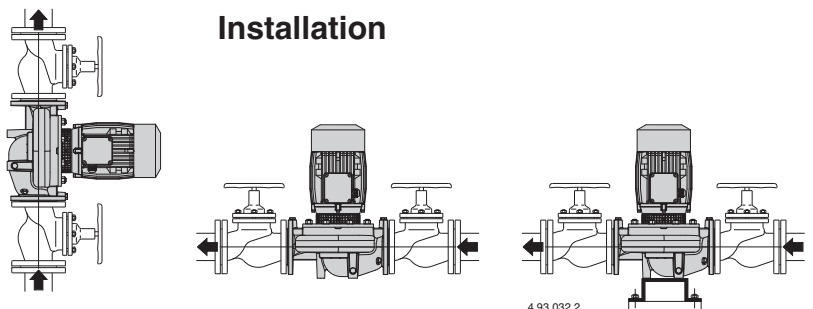

Dimensions and weights

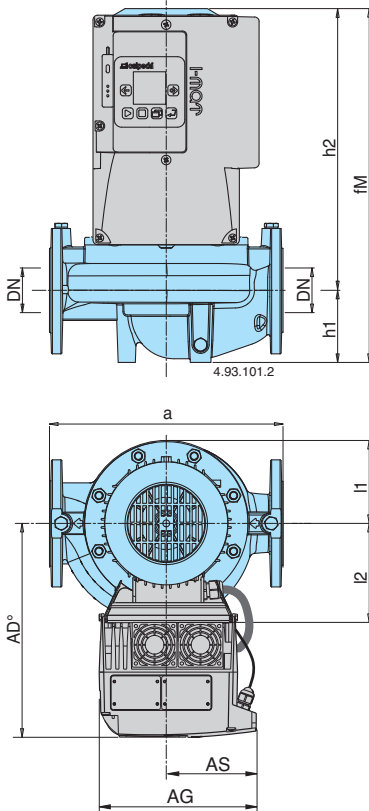

TYPE	mm											kg
	DN	a	fM	h1	h2	AD°	AG	AS	l1	l2	x	
NR EI 50D/A-C/B	50	320	399	90	270	270	190	105	93	100	70	28-30,2
NR EI 32/160A/A-B/A	32	340	421	80	341	286	190	105	102	102	60	35-33,3
NR EI 32/200B	32	440	469	85	384	286	210	118	126	126	60	43,8
NR EI 32/200A/A-S/A	32	440	495	85	410	294	210	118	126	126	60	51,5-54,5
NR EI 40/125A/A-B/A-C	40	320	420	81	339	286	190	105	93	98	70	35,9-33,9-32,9
NR EI 40/160B/A	40	320	430	81	349	286	190	105	119	119	75	41,4
NR EI 40/160A/A	40	320	470	81	389	286	210	118	119	119	75	47,5
NR EI 40/200A/A-B	40	440	496	81	430	294	210	118	140	140	75	64,1-61
NR EI 50/125C/A-F/A	50	340	437	90	347	286	190	105	96	115	75	37,9-35,9
NR EI 50/125A/B	50	340	477	90	387	286	210	118	96	115	75	43,6
NR EI 50/160C/B	50	340	480	90	390	286	210	118	120	128	75	49,1
NR EI 50/160A/B-B/A	50	340	506	90	416	294	210	118	120	128	75	59,3-56
NR EI 50/200D/B	50	440	516	100	416	294	210	118	140	140	80	67,2
NR EI 50/200A/A-B/A	50	440	544	100	444	368	281	153	140	140	80	92-84,5
NR EI 50/250C/B	50	440	657	100	557	393	281	153	175	175	85	128,8
NR EI 50/250B/B	50	440	707	100	557	393	281	153	175	175	85	135,8
NR EI 50/250A/B	50	440	732	100	632	471	350	190	175	175	85	184,5
NR EI 65/125F/B	65	340	494	105	389	286	210	118	121	145	95	53,5
NR EI 65/125S/B-A/B-D/A	65	340	520	105	415	294	210	118	121	145	95	63,6-63,6-62,1
NR EI 65/160A/A-B/A	65	340	552	105	447	368	281	153	121	142	95	88,8-82,3
NR EI 65/200B/B	65	475	666	105	561	368	281	153	140	153	90	122,8
NR EI 65/200A/B	65	475	716	105	611	393	281	153	140	153	90	128,8
NR EI 65/200S/B	65	475	741	105	636	471	350	190	140	153	90	177,5
NR EI 65/250C/B	65	475	722	105	567	393	281	153	175	175	90	148,8
NR EI 65/250B/B	65	475	747	105	642	471	350	190	175	175	90	190
NR EI 65/250A/C	65	475	793	105	688	491	350	190	175	175	90	-

Flanges PN 10, EN 1092-2

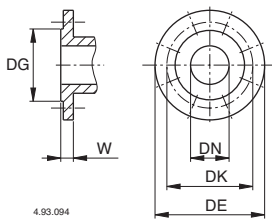

DN	mm					
	DG	DK	DE	Holes N°	Ø	W
32	76	100	140	4	19	18
40	84	110	150	4	19	18
50	99	125	165	4	19	20
65	118	145	185	4	19	20
80	132	160	200	8	19	22
100	156	180	220	8	19	24
125	184	210	250	8	19	24

TYPE	mm											kg
	DN	a	fM	h1	h2	AD°	AG	AS	l1	l2	x	
NR4 EI 50A/A-B/A-C/A	50	320	399	90	270	270	190	105	93	100	70	28,4-28,4-28,4
NR4 EI 65A/A-B/A-C/A	65	360	409	100	270	270	190	105	102	114	70	34,4-34,4-34,4
NR4 EI 100B/B-C/B	100	500	549	150	399	294	190	105	153	173	105	65,4-65,4
NR4 EI 100A/B	100	500	549	150	399	294	190	105	153	173	105	73,4
NR4 EI 125A/A-B/A-C/B	125	600	608	160	438	368	210	118	172	195	120	117,5-115,5-97,9
NR4 EI 32/160A-B	32	340	421	80	341	286	190	105	102	102	60	29,4-29,3
NR4 EI 32/200B-C	32	440	429	85	344	286	190	105	126	126	60	37,2-35,2
NR4 EI 32/200A/A	32	440	469	85	344	286	190	105	126	126	60	
NR4 EI 40/160A-B	40	320	430	81	349	286	190	105	119	119	75	37,9-37,4
NR4 EI 40/200B	40	440	430	81	349	286	190	105	140	140	75	45,9
NR4 EI 40/200A/A	40	440	470	81	349	286	190	105	140	140	75	49,4
NR4 EI 50/160B-C	50	340	440	90	350	286	190	105	120	128	75	41,9-39,9
NR4 EI 50/160A/B	50	340	480	90	350	286	190	105	120	128	75	43,9
NR4 EI 50/200A/B-B/B	50	440	516	100	416	294	190	105	140	140	80	62,4
NR4 EI 50/250C/B	50	440	516	100	416	294	190	105	175	175	85	83,9
NR4 EI 50/250A/B-B/B	50	440	545	100	445	368	210	118	175	175	85	101-86,4
NR4 EI 65/125D-F	65	340	454	105	349	286	190	105	121	145	95	45,4-43,4
NR4 EI 65/125S/B-A/B	65	340	494	105	349	286	190	105	121	145	95	48,4-48
NR4 EI 65/160A/B-B/B	65	340	504	105	399	294	190	105	121	142	95	49,1-48,9
NR4 EI 65/200C/B	65	475	536	105	431	294	190	105	140	153	90	58,4
NR4 EI 65/200B/B	65	475	536	105	431	294	190	105	140	153	90	66,4
NR4 EI 65/200A/B	65	475	552	105	447	368	210	118	175	175	90	70,9
NR4 EI 65/250C/B-D/B	65	475	555	105	450	365	210	118	175	175	90	81,9-81,9
NR4 EI 65/250A/A-B/A	65	475	555	105	450	368	210	118	175	175	90	105,5-92,5

Features

New Compact Design

A compact structure allows for simple installation even in confined spaces

A Unique Design

An innovative guard (patented) prevents contact with rotating parts, providing protection to the end user whilst allowing for inspection of the mechanical seal.

Advanced hydraulics

Optimum impeller geometry provides maximum efficiency and excellent suction characteristics.

Silent operation

Specially designed fluid ducts provide very quiet operation

Exceptional Fluid Dynamics

The fluid dynamics through the impeller and casing are designed to minimize losses and increase performance.

